



ARROW™
LOCK & DOOR HARDWARE

Mortice Locks

Rainer Security Products Ltd

Unit B6, Rudford Industrial Estate, Ford, Arundel, West Sussex BN18 0BF

☎ +44 (0) 1903 732211 🌐 rainersecurity.co.uk ✉ sales@rainersecurity.co.uk



AM/BM Series Mortise Locks

Premier Product

Arrow mortise locks are intended for heavy duty use in schools, hospitals and commercial buildings where security, durability and low maintenance are required. They are engineered for strength and performance, and precisely manufactured to exacting standards.



Certification/Compliance: **UL** **U**

ANSI

Meets A156.13 Series 1000, Operational Grade 1.

Federal

Meets FF-H-106C, Series 86 and 87.

UL/ULC Positive Pressure

All locks listed for A Label and lesser class doors, 4" (102mm) x 10" (254mm) single or 8" (203mm) x 10" (254mm) pair. Letter F and UL symbol on armored front indicate listing. **California State Reference Code** All levers with returns comply; levers return to within 1/2" (13mm) of door face.



Features:

Handing – Handed; field reversible. The lockset can be re-handed without disassembling the lock case.

Door Thickness – 1-3/4" (4mm) standard.

Backset – 2-3/4" (70mm).

Lockcase – Heavy gauge steel, with zinc dichromate finish for corrosion resistance. 5-7/8" (149mm) x 4" (102mm) x 15/16" (24mm).

Armored Front – Heavy gauge steel, 8" (203 mm) x 1-1/4" (32mm) x 3/32" (2mm). Accommodates flat doors and doors beveled 1/8" (3mm) in 2" (51mm).

Faceplate – Wrought brass, bronze or stainless steel. Attached by machine screws to lockcase front.

Latchbolt – Stainless steel, 2 piece mechanical with anti-friction insert. 5/8" (16mm) x 1" (25mm) x 3/4" (19mm) throw.

Auxiliary Latchbolt – 9/16" (14mm) effective throw and 3/8" (10mm) effective auxiliary latch deadlocking.

Deadbolt – One-piece stainless steel, 19/32" (15mm) x 1 1/4" (32mm) x 1" (25mm) throw.

Hub – Knob: nickel steel, 5/16" (8mm) and 9/32". Lever: nickel steel, 5/16" (8mm).

Spacing – Center to center, hub to cylinder: 3-5/8" (92mm). Center to center, hub to turnpiece 2-7/16" (62 mm).

ADA/Americans with Disabilities Act:

Acceptable Door Hardware: Section 4.13.9

Handles, pulls, latches and other operating devices on accessible doors shall have a shape that is easy to grasp with one hand and does not require grasping, tight pinching or twisting of the wrist to operate. Lever operated mechanisms, push-type mechanisms and "U" shaped handles are acceptable designs.

U Look for the universal symbol next to Arrow products that comply with ADA accessibility requirements.

Strike – Wrought brass, bronze or stainless steel. ANSI straight lip standard, 4-7/8" (124mm) x 1-1/4" (32mm) 1-1/8" (29mm) lip to center. Optional strikes, lip lengths and ANSI wrought strike box available.

Keys – Two nickel silver standard.

Keying Features Available:

- Master keying
- Construction master keying
- Visual key control
- Concealed key control
- Interchangeable core (IC) - Pointe, Choice Base, Plus, and Flex

Warranty – Five-year limited.

Standardized Case – One size case for uniform mortising.

Reversibility – Locks are easily reversed for change of hand.

Self Aligning Trim – Standard with rose trim. Eliminates bind, facilitates installation, gives support and saves labor.

Designs – Broad spectrum of designs including lever handles, knobs for roses and escutcheons in architectural finishes.

Complete Range of Functions – To meet all requirements.



AM/BM Series Mortise Locks

Premier Product



AM Series



BM Series

Finishes:



	BHMA	U.S. Equivalent	Arrow Equivalent	Finish
1	605	US3	03	Bright Brass
2	606	US4	04	Satin Brass
3	612	US10	10	Satin Bronze
4	613	US10B	10B	Dark Oxide Bronze, Oil Rubbed
5	625	US26	26	Bright Chromium Plated
6	626	US26D	26D	Satin Chromium Plated
7	629	US32	32	Bright Stainless Steel
8	630	US32D	32D	Satin Stainless Steel

Applications:

Arrow mortise locks are offered in a complete range of functions designed for commercial, institutional and industrial applications. They are engineered for strength and performance, and precisely manufactured to exacting standards.

A wide selection of trim designs and functions are offered which meet or exceed the performance requirements of ANSI Grade 1.

Arrow mortise locks can be found in the following types of facilities:

- Schools
- Office Buildings Facilities
- Multi-Family Housing
- Hospitals
- Government

Advantages:

- Easily reversible, enabling the user to reverse hands without disassembling lock case.
- Meets or exceeds ANSI operational Grade 1 requirements.
- Throughbolted trim designs for proper alignment and increased security.
- Many trim designs to complement Arrow cylindrical locks and exit device trims.
- Keyed into new or existing Arrow or competitive master key systems.

* Note: Not all trim designs available in all finishes.





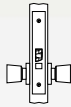
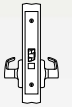
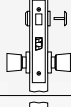
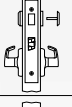
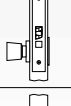
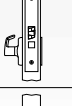
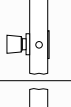
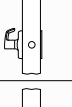
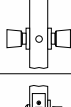
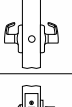
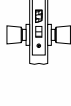
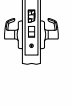
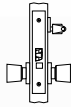
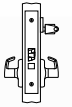
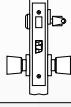
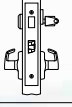
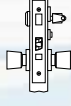
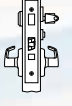
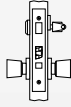
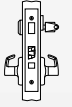

AM/BM Series Mortise Locks

Premier Product

ARROW	FUNCTION	ANSI/ FEDERAL #	AM SERIES	BM SERIES	DESCRIPTION
01	Passage	F01/86N			Latchbolt by knob/lever either side
02	Privacy	F19/86L			Latchbolt by knob/lever either side, except when outside is locked by turnpiece inside. Outside emergency release or operating from inside unlocks lock. Inside knob/lever retracts both bolts.
07	Exit				Latchbolt by knob/lever inside. Auxiliary latchbolt deadlocks latchbolt. No outside trim.
08	Single Dummy Trim				Rigid knob/lever one side of door only. Plug through edge of door ensures stability.
09	Double Dummy Trim				Rigid knob/lever both sides of door. Plug through edge of door ensures stability.
11	Apartment/Front Door	F12/86F			Latchbolt by knob/lever either side except when outside knob/lever is locked by stopworks in lock front, or when the deadbolt is projected. Deadbolt operates by key outside and turnpiece inside. Turning inside knob/lever will retract latchbolt and deadbolt simultaneously.
12	Storeroom	F07/86EW			Outside knob/lever always rigid. Latchbolt retracted only by key outside or by inside knob/lever. Auxiliary latchbolt deadlocks latchbolt.
13	Apartment/Front Door	F21/86B			Latchbolt operated by knob/lever either side. Deadbolt operated by key outside and turnpiece inside. When deadbolt is projected, key outside will retract deadbolt, then latchbolt.
15	Hotel	F15/86H			Inside knob/lever always free, while outside knob/lever is always rigid. Latchbolt operated by knob/lever inside and by key outside. All keys except emergency keys are shut out when deadbolt is projected by turnpiece inside. Turning inside knob/lever will retract both the deadbolt and the latchbolt simultaneously. Auxiliary latchbolt deadlocks latchbolt. Furnished with visual indicator button.
16	Hotel	F15/86H			Inside knob/lever always free, while outside knob/lever is always rigid. Latchbolt operated by knob/lever inside and by key outside. All keys except emergency keys are shut out when deadbolt is projected by turnpiece inside. Turning inside knob/lever will retract both the deadbolt and the latchbolt simultaneously. Auxiliary latchbolt deadlocks latchbolt.

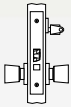
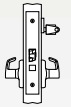
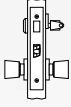
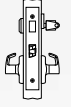
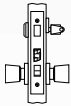

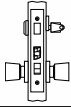

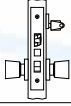
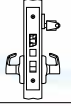
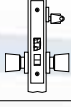
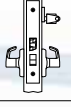
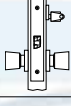
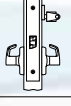
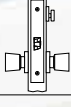
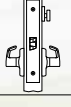
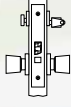
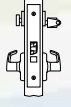
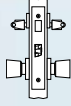
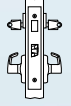
AM/BM Series Mortise Locks

Premier Product

ARROW	FUNCTION	ANSI/ FEDERAL #	AM SERIES	BM SERIES	DESCRIPTION
17	Classroom	F05/86J			Latchbolt operated by knob/lever either side, except when outside knob/lever is locked by key outside. Key operates latch or unlocks outside knob/lever. Inside knob/lever is always free. Auxiliary latchbolt deadlocks latchbolt.
19	Dormitory/Exit	F13/86FW			Latchbolt operated by knob/lever either side. When outside knob/lever is locked by projected deadbolt, (by inside turnpiece or outside key) key outside will retract deadbolt, then latchbolt. Turning inside knob/lever will retract latchbolt and deadbolt simultaneously, which will unlock outside knob/lever. When deadbolt is projected, the latchbolt is deadlocked.
20	Entrance/ Dormitory	F20			Latchbolt operated by knob/lever either side, except when outside knob/lever is locked by stopworks in lock front, or by projecting deadbolt by turnpiece inside or key outside. Turning inside knob/lever will retract latchbolt and deadbolt simultaneously. Deadbolt operated by turnpiece inside or key outside. When deadbolt is projected the latchbolt is deadlocked. Auxiliary latchbolt deadlocks latchbolt.
21	Front Door	F08,F10/86A			Latchbolt operated by knob/lever either side except when outside knob/lever is locked by stopworks in lock front. Deadbolt is operated by turnpiece inside. Key outside operates both bolts.
22	Office	F04/86E			Latchbolt operated by knob/lever either side except when outside knob/lever is locked by stopworks in lock front then operated by key outside. Auxiliary latchbolt deadlocks latchbolt.
23	Vestibule				Latchbolt operated by knob/lever either side, except when outside knob/lever is locked by stopworks in lock front, then operated by key outside.
24	Storeroom				Latchbolt operated by knob/lever inside and by key outside. Outside knob/lever always rigid. Inside knob/lever always free.
26	Privacy	F22/86L			Latchbolt by knob/lever either side, except when outside is locked by turnpiece inside. Operating inside knob/lever, closing door, or with outside emergency release unlocks outside.
27	Institutional				Latchbolt by knob/lever either side, except when Privacy outside is locked by turnpiece inside. Operating inside knob/lever or closing door unlocks outside. Key outside retracts latch at all times, even if thumbturn is held in locked position. Auxiliary latch deadlocks latchbolt.
31	Storeroom	F14/86C			Latchbolt operated by knob/lever either side. Deadbolt is operated by key from either side. When deadbolt is projected, key either side will retract deadbolt, then latchbolt.

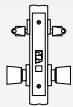
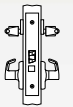
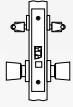
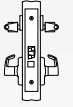
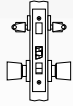
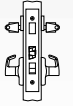
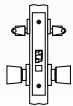
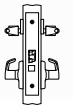
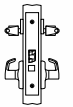
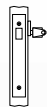
AM/BM Series Mortise Locks

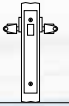
Premier Product

ARROW	FUNCTION	ANSI/ FEDERAL #	AM SERIES	BM SERIES	DESCRIPTION
32	Vestibule	F09/86G			Latchbolt operated by knob/lever either side, except when outside knob/lever is locked by key from the inside cylinder. When outside knob/lever is locked, latchbolt is retracted by key outside or by knob/lever inside. Auxiliary latchbolt deadlocks latchbolt.
33	Storeroom	F30			Both knobs/levers rigid at all times. Auxiliary latchbolt deadlocks latchbolt. Latchbolt operated only by key from either side.
34	Storeroom	F35			Latchbolt operated by knob/lever either side except when the outside knob/lever is locked by stop works in lock front then operated by key outside or by knob/lever inside. Deadbolt operated by key from either side.
37	Classroom	F32			Latchbolt by knob/lever either side. Except when outside is locked from inside or outside by key. When outside is locked, latchbolt is retracted by key from inside or outside or by operating inside knob/lever. Auxiliary latch deadlocks latchbolt.
38	Classroom				Latchbolt by lever from either side unless outside lever is locked by projection of deadbolt. Deadbolt thrown by key from either side. Inside lever simultaneously retracts latchbolt and deadbolt, outside lever remains locked. Retracting latchbolt by key unlocks outside lever. Auxiliary latch deadlocks latchbolt.
40	Deadlock	F18/86S			Deadbolt operated only by key outside. (No trim)
41	Deadlock	F17/86P			Deadbolt operated by key outside and turnpiece inside. (No trim)
42	Deadlock	F16/86T			Deadbolt operated by key from either side. (No trim)
44	Classroom Deadlock				Deadbolt by key outside. Turnpiece will retract but will not project bolt.

Electrical Lock Functions:

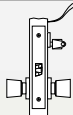
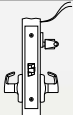
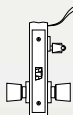
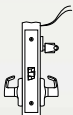
AM17/BM17 SUFFIX	VOLTAGE	CURRENT			DESCRIPTION
177 179	12V AC/DC 24V AC/DC	612mA 330mA			FAIL SAFE: Power on locks outside lever. Inside lever always free. Latch retracted by key when locked electrically.
181 183	12V AC/DC 24V AC/DC	612mA 330mA			FAIL SECURE: Power off locks outside lever. Inside lever always free. Latch retracted by key when locked electrically.

AM/BM Series Mortise Locks

Premier Product

Reversing Hand:

Mortise Locksets AM/BM Series

Please read completely before proceeding and review the drawing below.

Minimal force is required to reverse handing.

1. Remove the armored front.
2. Remove the lockset from the door.
3. Fully depress the latchbolt and hold in the depressed position.
4. With minimal force, depress the catch plate, located at the end of the latchtail, through the oblong cutout in the lockcase cap. While depressing the catch plate, release the latchbolt and remove latch from the lock.
5. Turn the latchbolt over and reinstall into the lock.
6. Depress the latchbolt until it re-engages the tail socket.
7. Remove the red headed screw from the stopworks and place it in the stopworks on the opposite side of the case.
8. Loosen the front screw to change the bevel. Tighten the front screws.
9. Reinstall the lock and armored front into the door.
10. If changing bevel only, i.e. RH to RHR. Omit step 7.

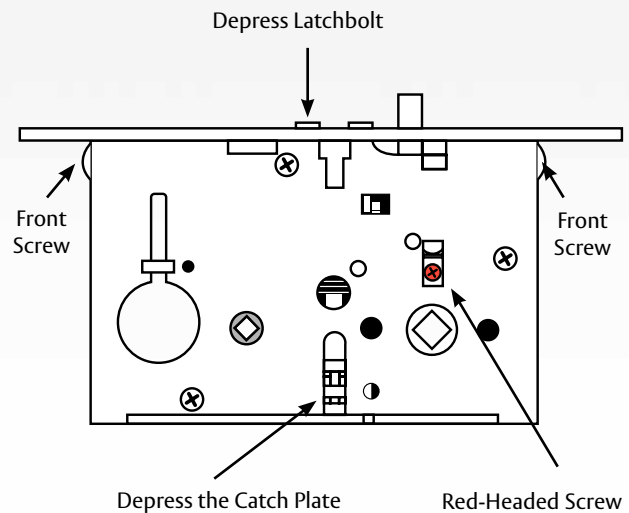

AM/BM Series Mortise Locks – AM Series Knob Designs

Premier Product

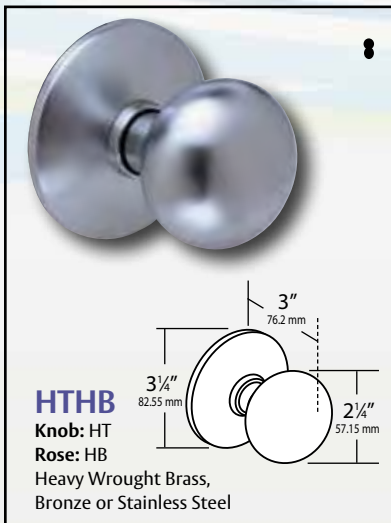
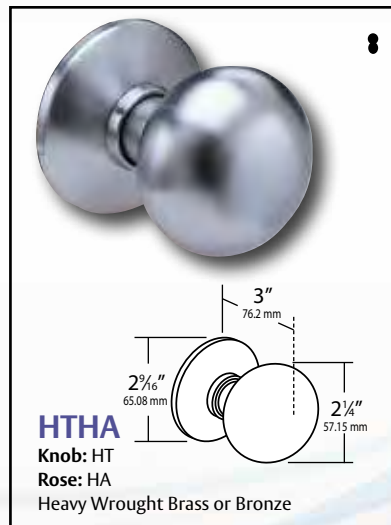
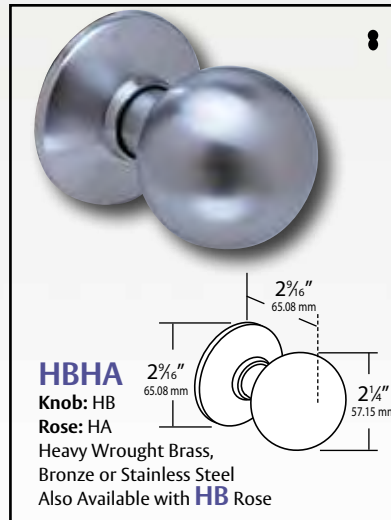
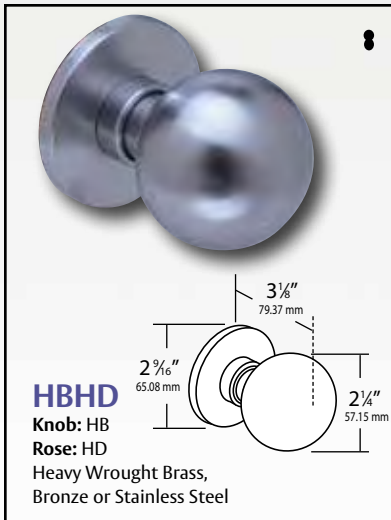

AM/BM Series Mortise Locks – AM Series Knob Designs

Premier Product

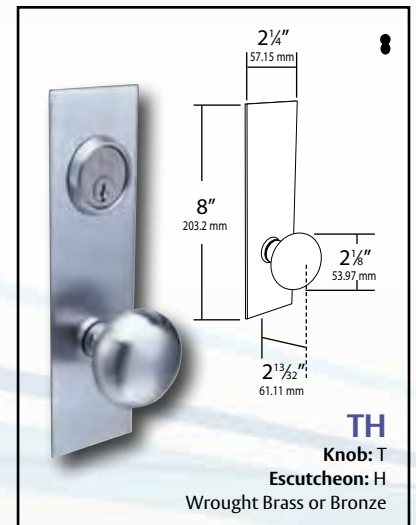
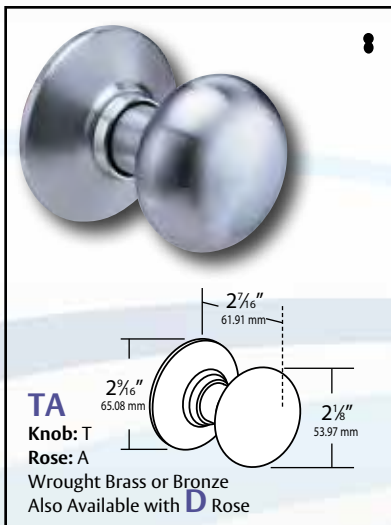
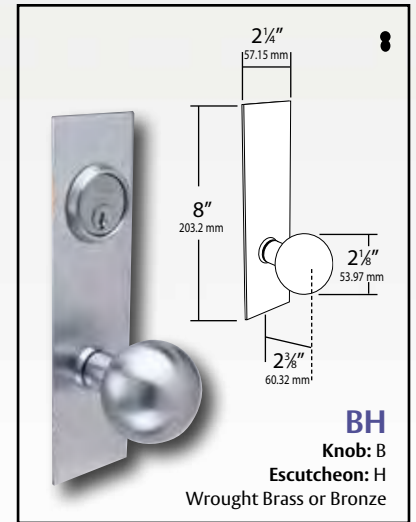
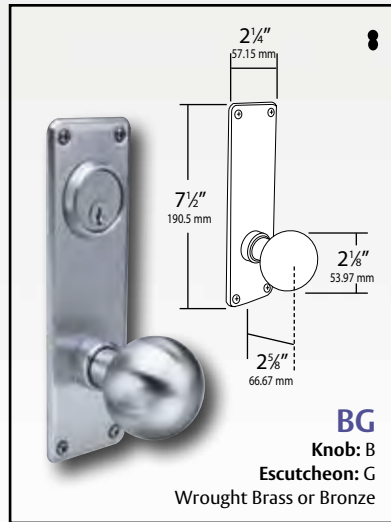

AM/BM Series Mortise Locks – BM Series Lever Designs

Premier Product

Broadway:

BRL
 Lever: BR - Cast
 Rose: L - Wrought Brass, Bronze or Stainless Steel

Technical drawing dimensions: 2 1/4" (57.15 mm) for the rose diameter, 4 3/4" (120.65 mm) for the lever length, and 74.61 mm for the mounting hole offset.

BRG
 Lever: BR - Brass or Bronze
 Escutcheon: G - Brass or Bronze or Stainless Steel

Technical drawing dimensions: 2 1/4" (57.15 mm) for the escutcheon width, 7 1/2" (190.5 mm) for the escutcheon height, 2 5/8" (66.67 mm) for the lever offset, and 4 3/4" (120.65 mm) for the lever length.

BRH
 Lever: BR - Cast
 Escutcheon: H - Wrought Brass, Bronze or Stainless Steel

Technical drawing dimensions: 2 1/4" (57.15 mm) for the escutcheon width, 8" (203.2 mm) for the escutcheon height, 2 5/8" (66.67 mm) for the lever offset, and 4 3/4" (120.65 mm) for the lever length.

Hastings:

HSL
 Lever: HS - Cast
 Rose: L - Brass, Bronze or Stainless Steel

Technical drawing dimensions: 2 1/4" (57.15 mm) for the rose diameter, 2 15/16" (74.61 mm) for the lever offset, and 4 3/4" (120.65 mm) for the lever length.

HSG
 Lever: HS - Cast
 Escutcheon: G - Wrought Brass, Bronze or Stainless Steel

Technical drawing dimensions: 2 1/4" (57.15 mm) for the escutcheon width, 7 1/2" (190.5 mm) for the escutcheon height, 2 5/8" (66.67 mm) for the lever offset, and 4 3/4" (120.65 mm) for the lever length.

HSH
 Lever: HS - Cast
 Escutcheon: H - Wrought Brass, Bronze or Stainless Steel

Technical drawing dimensions: 2 1/4" (57.15 mm) for the escutcheon width, 8" (203.2 mm) for the escutcheon height, 2 5/8" (66.67 mm) for the lever offset, and 4 3/4" (120.65 mm) for the lever length.

Javelin:

JL
 Lever: J - Forged Brass or Cast Bronze
 Rose: L - Wrought Brass or Bronze

Technical drawing dimensions: 2 1/4" (57.15 mm) for the rose diameter, 2 1/4" (57.15 mm) for the lever offset, and 4" (101.60 mm) for the lever length.

JG
 Lever: J - Forged Brass or Cast Bronze
 Escutcheon: G - Wrought Brass, Bronze or Stainless Steel

Technical drawing dimensions: 2 1/4" (57.15 mm) for the escutcheon width, 7 1/2" (190.5 mm) for the escutcheon height, 2 1/4" (57.15 mm) for the lever offset, and 4" (101.60 mm) for the lever length.

JH
 Lever: J - Forged Brass or Cast Bronze
 Escutcheon: H - Wrought Brass, Bronze or Stainless Steel

Technical drawing dimensions: 2 1/4" (57.15 mm) for the escutcheon width, 8" (203.2 mm) for the escutcheon height, 2 1/4" (57.15 mm) for the lever offset, and 4 3/4" (120.65 mm) for the lever length.

AM/BM Series Mortise Locks – BM Series Lever Designs

Premier Product

Neo:

NL

Lever: N - Brass, Bronze or Stainless Steel
Rose: L - Brass, Bronze or Stainless Steel

NG

Lever: N - Brass, Bronze or Stainless Steel
Escutcheon: G - Brass, Bronze or Stainless Steel

NH

Lever: N - Brass, Bronze or Stainless Steel
Escutcheon: H - Brass, Bronze or Stainless Steel

Ventura:

VL

Lever: V - Forged Brass, Cast Bronze or Stainless Steel
Rose: L - Wrought Brass, Bronze or Stainless Steel

VG

Lever: V - Forged Brass, Cast Bronze or Stainless Steel
Escutcheon: G - Wrought Brass, Bronze or Stainless Steel

VH

Lever: V - Forged Brass, Cast Bronze or Stainless Steel
Escutcheon: H - Wrought Brass, Bronze or Stainless Steel

Wave:

WL

Lever: W - Brass, Bronze or Stainless Steel
Rose: L - Brass, Bronze or Stainless Steel

WG

Lever: W - Brass, Bronze or Stainless Steel
Escutcheon: G - Brass, Bronze or Stainless Steel

WH

Lever: W - Brass, Bronze or Stainless Steel
Escutcheon: H - Brass, Bronze or Stainless Steel

AM/BM Series Mortise Locks – BM Series Lever Designs

Premier Product

Xavier:

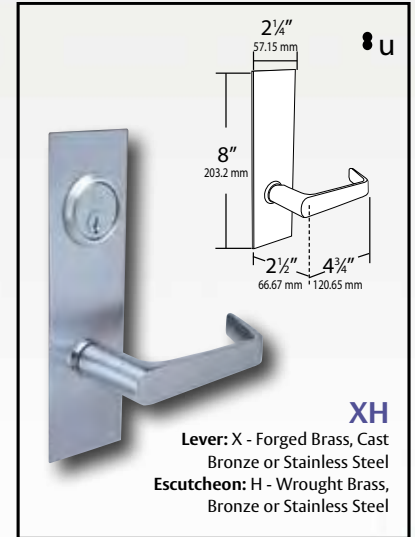
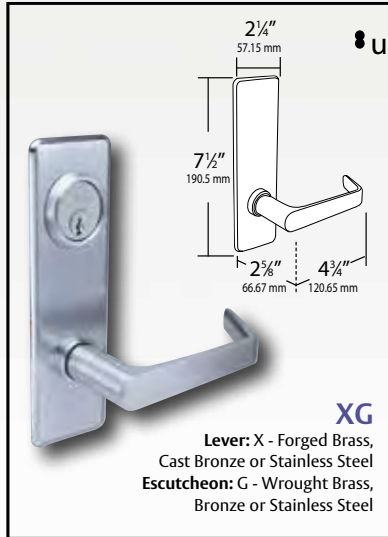
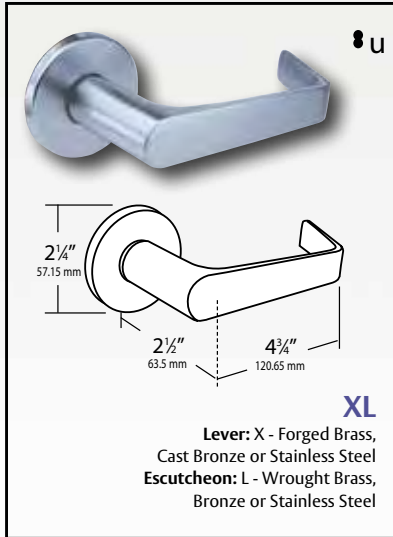







Strikes:

ANSI Straight Lip (standard)

- Brass or bronze
- Non-handed
- 4-7/8" (124mm) x 1-1/4" (32mm) x 1-1/8" (29mm) lip to center
- Optional lip lengths: 7/8" (22mm), 1-1/4" (32mm), 1-3/8" (35mm), 1-1/2" (38mm), 1-3/4" (44mm), 2" (51mm), 2-1/4" (57mm), 2-1/2" (64mm), 2-3/4" (70mm), 3" (76mm)

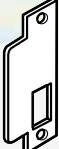
ANSI Curved Lip

- Brass or bronze
- Handed
- 4-7/8" (124mm) x 1-1/4" (32mm) x 1-1/4" (32mm) lip to center
- Optional lip lengths: 1-3/8" (35mm), 1-1/2" (38mm), 1-3/4" (44mm), 2" (51mm), 2-1/4" (57mm), 2-1/2" (64mm), 2-3/4" (70mm), 3" (76mm)

		PART NO.	DESCRIPTION
Latchbolt x Deadbolt Functions: 02,11,13,15,16, 19,20,21,31,34,38		460	Straight Lip
		468	Curved Lip for RH
		466	Curved Lip for LH
Latchbolt Only Functions: 01,07,12,17,22,23, 24,26,27,32,33,37		463	Straight Lip
		464	Curved Lip for RH
		462	Curved Lip for LH
Deadbolt Only Functions: 40,41,42,44		456	Straight Lip

Note: Straight lip strikes are standard.
 Specify if curved lip strike is required.

AM/BM Series Mortise Locks

Premier Product

Cylinder:

Cylinder

- MC61 - 1-1/8" for 1-3/4" door. Collar-16-113A
- Hotel Cylinder
For function 15 and 16.
MCH61 - 1-18" for 1-3/4" door. Collar-16-113A
- Finishes - 3, 4, 10, 10B, 26, 26D.

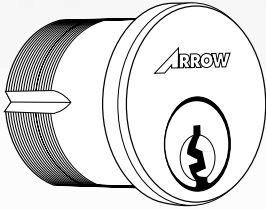

Cylinder for Interchangeable Core

- 16CR-16 - 6 pin-1-1/8" - MCF (UK)
- 16CR-27 - 6 or 7 pin 1-1/4" - MCF (UK)
- 16CRH-26 - 6 pin, hotel
- Collar - 16-113A
- Finishes - 3, 4, 10, 10B, 26, 26D

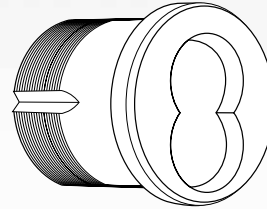

Cylinder Collars:

I.C. Mortise Cylinder Collar 16-113A (Standard for 16CR-14, 16CR-26, 16CRH-26)

I.C. Rim Cylinder Collar 16RC-113 (Standard for 16RCR-16, 16RCR-27)

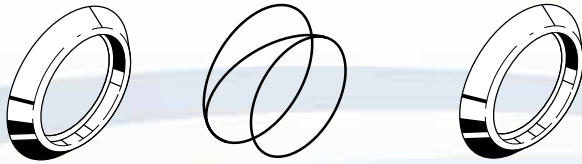

Spacer Rings:

16CR-123-1 1/8" Thick

16CR-123-2 1/4" Thick

16CR-123-3 (Standard for 16RCH-26) 3/8" Thick



Thumb Turn 16-17A:

- Furnished with rose trim. For escutcheon trim, thumb turn is mounted on escutcheon.
- Finishes - 3, 4, 10, 10B, 26, 26D.

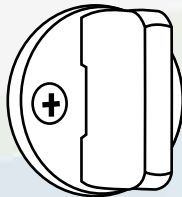

Cams:

001



Used with functions
12, 17, 22, 23, 24, 27,
32 (I/S), 33, 37.

AM2



Used with deadbolt functions
11, 13, 15, 16, 19, 20, 21, 31, 32
(O/S), 34, 38, 40, 41, 42, 44.

AM/BM Series Mortise Locks

Premier Product

Face Plates (Scalps):

Part No.
AM-15-305

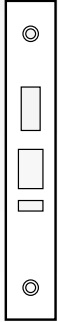

Function
15, 16, 38

Part No.
AM11-305

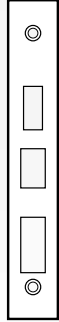

Function
11, 21, 34

Part No.
AM12-305



Function
07, 12, 17
27, 32, 33, 37

Part No.
AM02-305



Function
02, 13, 19, 31

Part No.
AM22-305



Function
22

Part No.
AM23-305

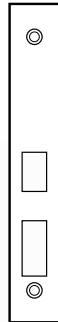

Function
23

Part No.
AM41-305



Function
40, 41, 42, 44

Part No.
AM01-305

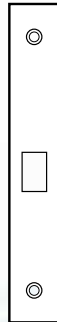

Function
01, 24, 26

Part No.
AM20-305



Function
20

Spindles:



Knob Spindle

AM 385A–For trim with “H” escutcheon
AM 386A–For trim with “G” escutcheon and all rose trim

NOTE: AM 385A–Inside half-P/N-16-385
Outside half-P/N-BM-383
AM 386A–Inside half-P/N-16-385
Outside half-P/N-BM-383-2



Lever Spindle

BM 385A–For trim with “H” escutcheon and rose trim
BM 386A–For trim with “G” escutcheon

NOTE: BM 385A–Inside half (assembly with screw) 17S-384A
Outside half-BM-383
BM 386A–Inside half (assembly with screw) 17S-385A
Outside half-BM-383-2

AM/BM Series Mortise Locks

Premier Product

Suggested Specification AM/BM:

All locksets shall be Mortise Locksets as supplied by Arrow Lock company.

Locks shall have all functions available in one size case, manufactured from heavy gauge steel, minimum thickness 3/32", chrome plated for corrosion resistance and lubricity of parts. The handing of all locks shall be reversible without the disassembly of the lockcase. Cases are to be closed on all sides to protect internal parts. Locks are to have adjustable, beveled and armored fronts, standard 2-3/4" backset, a full 3/4" throw two-piece mechanical anti-friction latchbolt, and a one-piece stainless steel 1" throw deadbolt, and shall be available for a minimum door thickness of 1-3/8". Internal parts shall be heavy gauge steel, zinc dichromate plated for corrosion resistance.

All locksets with latchbolts, regardless of trim, shall be listed by Underwriters Laboratories for A label and lesser class doors, 4' x 10' single or 8' x 10' pair. Cylinder options shall include interchangeable core.

Lock trim (knob, lever, sectional or escutcheon) shall be throughbolted through the lockcase to assure correct alignment and proper operation.

Certification:

ULC-7(1997) and UL10C-Positive Pressure
 Federal Specification FF0H-106G
 ANSI A156.13 Series 1000, Operational Grade 1
 ANSI A117.1, Accessibility Code, 1989 (Formerly Tile 19, California State Fire Marshal Standard) (lever handle trim).

All locks, trim, and cylinders shall be from one manufacturer.

All locksets shall carry a five-year limited warranty.



Order Example:

Example: To order a AM Series Apartment function Mortise lock with HTHA design, satin chrome finish, with a straight lip strike, right handed, keyed different.

Specify:

